

Standard Preparation 1400 mm Work Table with Upstand - Right Bowl

ITEM # _____

MODEL # _____

NAME # _____

SIS # _____

AIA # _____

132761 (TL1410DXPN)

 Work Table with right/ hand
 bowl and upstand, 1400mm

Short Form Specification

Item No.

The 50mm high worktop in 304 AISI stainless steel, 1mm in thickness, incorporates a layer of sound deadening material, has upturned edges and a reinforced, waterproof under panel. Integral radiused rear upstand, h=100mm. Square section legs 40x40mm on 1" height-adjustable feet in 304 AISI stainless steel.

Single-pressed bowl mm 400x400x200h, with overflow pipe and drain hole.

Main Features

- The table can be ordered with the drawer of 400 mm or 600 mm (optional accessory): thanks to the design of the drawer, additional drawers can be added to the first single drawer to create chest of 2, 3 or 4 drawers based on customer's needs.
- Sturdiness, stability and reliability of table accurately tested.

Construction

- 50 mm worktop in 304 AISI stainless steel, 10/10 in thickness with upturned edges and reinforced waterproof underpanel, incorporates a layer of sound deadening materials.
- Square section legs and 40 mm height-adjustable feet in 304 AISI stainless steel.
- Single-pressed bowl AISI 304 stainless steel bowl with overflow pipe and drain hole.
- Table top slots into legs without using screws to facilitate installation.
- 400 or 600 mm wide single drawer, chest of 4 drawers, lower shelf, three-sided underframe and set of castors as alternative to the feet, can be fitted as optional on all work tables.
- 40 mm-thick lower shelf (available as optional accessory on some models) slots easily into place at a height of 200 mm from the floor. Lower shelf is compulsory to install the chest of drawers.
- Delivered in knock-down package.
- 100 mm upstand with 10 mm radiused corner and 13 mm deep, designed to be used against a wall.
- Upstand back completely covered with Stainless Steel welded profile.

Optional Accessories

- Lower shelf for 1400mm tables and sinks PNC 855146
- Set of 4 wheels (2 with brake) d. 100mm for tables and sinks (total height on wheels= 993 mm) PNC 855150
- 3-sided underframe for 1400mm tables PNC 855153
- Single drawer GN 1/1, 400mm PNC 855280
- Single drawer, 600mm PNC 855281
- Additional drawer, 600mm (to set up a chest of 2, 3, 4 drawers) PNC 855295
- Additional drawer GN 1/1, 400mm (to set up a chest of 2, 3, 4 drawers) PNC 855298
- Elbow operated mixer tap with spout 3/4", single hole PNC 855322
- Elbow operated mixer tap with short spout 3/4", single hole PNC 855323
- Foot operated mixer tap (hot and cold) with spout 3/4" PNC 855328

APPROVAL: _____

Key Information:

External dimensions, Width:	
132761 (TL1410DXPN)	1400 mm
External dimensions, Depth:	700 mm
External dimensions, Height:	1000 mm
Upstand Dimensions, Height:	100 mm
Upstand Dimensions, Depth:	13 mm
Upstand Dimensions, Radius:	R=10
Bowls number	1
Bowl dimensions	400x400xH200
Worktop thickness:	50 mm
Net weight:	45 kg

Front

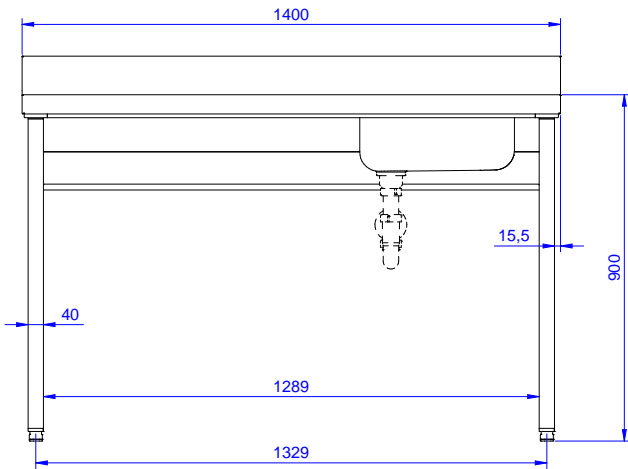

Side

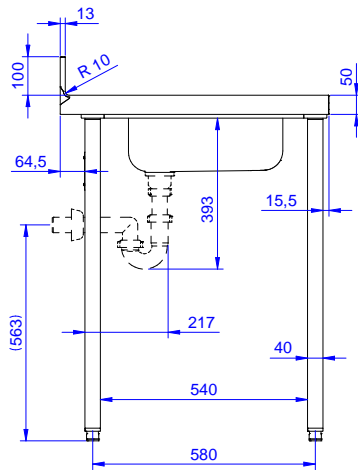

D = Drain

Top

